



BRVSTON



BHA-1
OWNER'S MANUAL

IMPORTANT SAFETY INSTRUCTIONS

 The lightning flash with arrowhead symbol within an equilateral triangle, is intended to alert the user to the presence of un-insulated “dangerous voltage” within the product’s enclosure that may be of sufficient magnitude to constitute a risk of electric shock to persons.

 The exclamation point within an equilateral triangle is intended to alert the user to the presence of important operating and maintenance (servicing) instructions in the literature accompanying the product.

1. Read these instructions.
2. Keep these instructions.
3. Heed all warnings.
4. Follow all instructions.
5. Do not use this apparatus near water.
6. Clean only with dry cloth.
7. Do not block any ventilation openings. Install in accordance with the manufacturer’s instructions.
8. Do not install near any heat sources such as radiators, heat registers, stoves, or other apparatus (including amplifiers) that produce heat.
9. Do not defeat the safety purpose of the polarized or grounding-type plug. A polarized plug has two blades with one wider than the other. A grounding type plug has two blades and a third grounding prong. The wide blade or the third prong are provided for your safety. If the provided plug does not fit into your outlet, consult an electrician for replacement of the obsolete outlet.
10. Protect the power cord from being walked on or pinched particularly at plugs, convenience receptacles, and the point where they exit from the apparatus.
11. Only use attachments/accessories specified by the manufacturer.
12. Use only with the cart, stand, tripod, bracket, or table specified by the manufacturer, or sold with the apparatus. When a cart is used use caution when moving the cart/apparatus combination to avoid injury from tip-over.
13. Unplug this apparatus during lightning storms or when unused for long periods of time.
14. Refer all servicing to qualified service personnel. Servicing is required when the apparatus has been damaged in any way, such as power-supply cord or plug is damaged, liquid has been spilled or objects have fallen into the apparatus, the apparatus has been exposed to rain or moisture, does not operate normally, or has been dropped.



WARNING: TO REDUCE THE RISK OF FIRE OR ELECTRIC SHOCK, DO NOT EXPOSE THIS APPARATUS TO RAIN OR MOISTURE.

DO NOT EXPOSE THIS EQUIPMENT TO DRIPPING OR SPLASHING AND ENSURE THAT NO OBJECTS FILLED WITH LIQUIDS, SUCH AS VASES, ARE PLACED ON THE EQUIPMENT.

TO COMPLETELY DISCONNECT THIS EQUIPMENT FROM THE AC MAINS, DISCONNECT THE POWER SUPPLY CORD PLUG FROM THE AC RECEPTACLE. THE MAINS PLUG OF THE POWER SUPPLY CORD SHALL REMAIN READILY OPERABLE.

BRYSTON LIMITED WARRANTY

Bryston analog audio products are warranted to be free from manufacturing defects for twenty (20) years from the original date of manufacture. The warranty includes parts and labour.

Bryston Digital products and cables are warranted for five years from the original date of manufacture. The warranty includes parts and labour.

Bryston products having motorized moving parts, excluding motorized volume controls, are warranted for three years from the original date of manufacture. The warranty includes parts and labour.

Bryston will remedy the problem by repair or replacement, as we deem necessary, to restore the product to full performance. Bryston will pay return shipping costs for the full length of the specific product’s warranty.

In the event of a defect or malfunction, contact Bryston’s repair centers for return authorization. Products must be returned using original packaging material only. Packing material may be purchased from Bryston if necessary. This warranty is considered void if the defect, malfunction or failure of the product or any component part was caused by damage (not resulting from a defect or malfunction) or abuse while in the possession of the customer. Tampering by persons other than factory authorized service personnel or failure to fully comply with Bryston operating instructions voids the warranty. This warranty gives you specific legal rights and you may also have other rights which may vary from province to province and country to country.

As of 2006-02-22 Bryston will only warranty Bryston products purchased through authorized Bryston dealers. Bryston products with a date code of 0608 or higher (date code format is “yyww”, where “yy” is the two least significant digits of the year and “ww” is the week of the year) must be accompanied by a copy of the bill-of-sale from a Bryston authorized dealer to qualify for warranty service. The warranty is transferable from the original owner to a subsequent owner as long as a copy of the bill-of-sale from the original authorized Bryston dealer accompanies the re-sale. The copy of the bill of sale to any subsequent owner need ONLY include the Name of the Bryston Authorized Dealer and the Model and Serial number of the Bryston product. The warranty will only be honored in the country of the original purchase unless otherwise pre-authorized by Bryston.

BRYSTON SERVICE in CANADA:

Postal address: **PO. BOX 2170, Stn. Main
PETERBOROUGH, ONTARIO
CANADA K9J 7Y4**

Courier address: **677 NEAL DRIVE
PETERBOROUGH, ONTARIO
CANADA K9J 6X7**

**PHONE: 705-742-5325
FAX: 705-742-0882
E-mail: cdnser@bryston.com**

BRYSTON SERVICE in the USA:

**79 COVENTRY ST., Suite 5
NEWPORT, VERMONT
U.S.A. 05855-2100**

**PHONE: 802-334-1201
FAX: 802-334-6658
E-mail: usaser@bryston.com**

BRYSTON SERVICE outside Canada and the USA:

contact your local distributor or

**CHECK OUR WEB SITE: www.bryston.com
E-MAIL BRYSTON DIRECTLY: cdnser@bryston.com
FAX BRYSTON DIRECTLY: 01-705-742-0882
PHONE BRYSTON DIRECTLY: 01-705-742-5325**

TABLE of CONTENTS

Safety Instructions, Warranty and Contact Information	Opposite
General Information	Page 1
Introduction	
General Description	
Installation & Setup	
Power Conditioners	
XLR Connector Options	
Fuses	
Driving Multiple Pairs of Headphones.....	Page 2
Wiring Headphones for Balanced Operation	
Front Panel Legend.....	Page 3
Input Select Switch	
Gain Select Switch	
Volume Control	
Balance Control	
Balanced Outputs	
Single Ended Output	
Status LED	Page 4
Power Switch	
Rear Panel Legends	
Power Inlet	
Fuse Drawer	
Fuse Label & Warnings	
Remote Trigger Connector	
Mini Jack Input	Page 5
Single-Ended Inputs	
Balanced Inputs	
Data Plate	
Connecting the BHA-1 to the MPS-2 External PSU	
Remote Trigger (Power On/Off) Control.....	Page 6
Technical Specifications	
Overall Schematic	Page 7
External Dimensions.....	Page 8

INTRODUCTION:

Thank you for choosing the Bryston BHA-1 Head Phone Amplifier. We welcome any suggestions you may have, or comments regarding the operation of your amplifier. We consider you, our customer, to be Bryston's most important resource, and your opinion is very much appreciated. No warranty card is necessary to initiate your coverage. Refer to the back page for detailed warranty information. Please save the original box and all packing materials. Always use the original packing materials when shipping or moving the BHA-1.

GENERAL DESCRIPTION:

The BHA-1 is a stereo headphone amplifier that features:

- Balanced dual mono circuitry
- High quality laser trimmed Noble stereo Volume control
- Left/Right balance control
- 6 fully discrete class A Bryston operational amplifiers
- Balanced outputs: 4 pin stereo and dual left/right 3 pin outputs
- Stereo ¼ inch single ended outputs
- 14dB or 20dB of selectable gain available
- All input and output connectors are Gold plated
- 10k input impedance
- Multiple headphone drive capability
- Power supply options:
 - Standard: high quality Bryston internal analog power supply
 - Optional: External MPS-2 power supply (replaces internal supply)

INSTALLATION & SETUP:

Check the label next to the power input connector on the rear of the BHA-1 and verify your amplifier complies to your local A/C voltage and frequency requirements.

The BHA-1 is a convection cooled amplifier. The entire enclosure, and the aluminum top in particular, acts as a large surround heat sink helping to transfer heat to the surrounding air. Therefore the BHA-1 installation should allow for unrestricted air flow around it. We recommend maintaining at least 3 inches of clear space to the sides and top of the amplifier. The BHA-1 should not be installed near other heat sources like heating vents or radiators. The BHA-1 should not be

installed in tight enclosed areas.

Bryston recommends that at least 6 inches of space be provided to the rear of the amplifier for properly dressing input, output and power cables.

POWER CONDITIONERS:

Bryston urges caution in choosing a power conditioner for your audio/video system. Large power amplifiers can draw very substantial current from the wall plug, and many so-called power conditioners can in fact hinder the supply of current by inserting resistances in series with the line cord. However, there are now power conditioners that can reduce or eliminate RF and 'hash' from the AC supply and may actually improve current delivery to your system. This type of power conditioner (exemplified by Bryston B.I.T. Power Conditioners) uses the energy storage in a large toroidal transformer to provide high instantaneous power and reduce the substantial AC output resistance of the wall socket and house wiring. This resistance can be in the range of 0.5 to 1 Ohm and is typically reduced to only a few milli-ohms by the Power Conditioner. That in turn considerably reduces Voltage drop in the power line on high current surges and quite substantially increases the stability of the power line improving audio (and video) focus, precision and clarity.

XLR CONNECTOR OPTIONS:

Although the pictures and illustrations in this manual show all female non-locking connectors, all XLR connectors are available with locking mechanisms on a special order basis. Also, the XLR output connectors on the front panel are available in either gender (male or female).

FUSE:

The BHA-1 has a single, fast acting 5x20mm tubular glass fuse, located in a locking drawer that is integrated into the power inlet (see pg's 6 & 7). Turn off the unit and remove the power cord before attempting to remove and replace the fuse. Replace fuse with the type and value stated on the fuse label. In the event of a discrepancy, follow the data on the fuse label.

For 100-120VAC models: F 2A/250V

For 200-240VAC models: F 1A/250V

DRIVING MULTIPLE PAIRS OF HEADPHONES

While the BHA-1 is capable of driving multiple pairs of headphones from its three outputs (single 4 pin XLR jack, dual 3 pin XLR jacks and 1/4" stereo phone jack) the total power delivered should be less than or equal to the rated output power in order to maintain optimum performance. While more power can be delivered, this will cause the class A amplifier stages to run hotter and performance may suffer. The internal heat generated is primarily determined by the power delivered to the load(s). Unfortunately there is no easy way to determine in advance how much power headphones would be using as this would require knowing not only the load impedances but also the output voltage levels and that is determined by listening levels in conjunction with the headphones' efficiency.

Note that the three outputs are in parallel being driven from the same output amplifiers. Also, though we recommend that the load impedance be greater than **32 Ohms** it can be as low as 16 Ohms.

To connect multiple pairs of **unbalanced** headphones DO NOT use the balanced output jacks as this could damage the BHA-1. Each half of either balanced output is driven from a separate amplifier in a bridged configuration (for a total of 4 output amplifiers) and thus there is no common ground. **Unbalanced** (also referred to as *single ended*) headphones should only be connected to the **unbalanced** output connector (a 1/4" 3-conductor phone jack on the front panel). A suitable "Y" adaptor to facilitate driving two **unbalanced** headphones from the unbalanced output jack to is shown below. This is a typical "Y" adaptor and should be readily available.

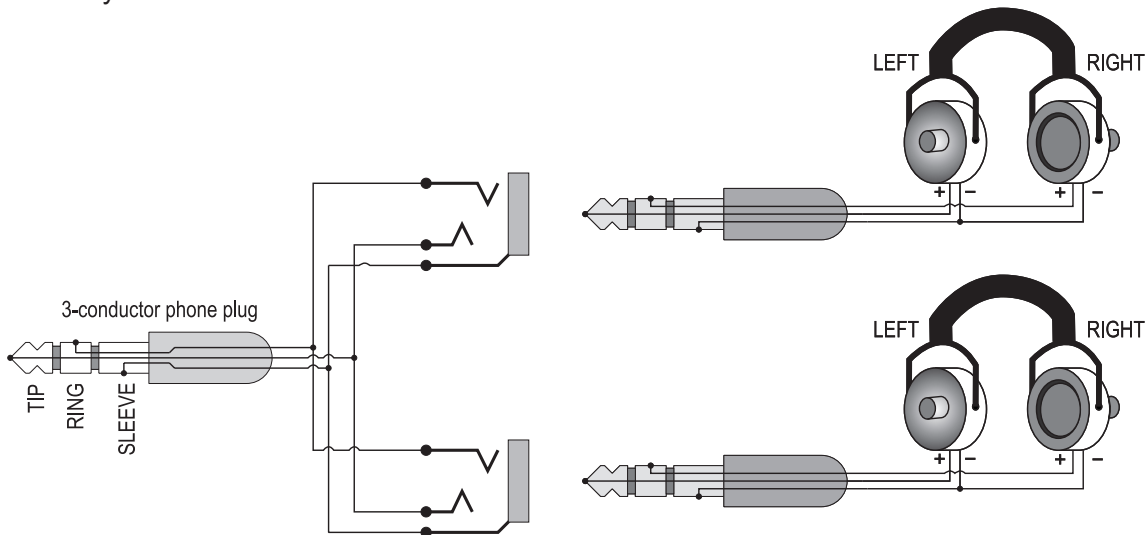

WIRING HEADPHONES FOR BALANCED OPERATION

For headphones that have a separate pair of wires (+ and - phase) from each side, maximum performance can be obtained by wiring these headphones for fully balanced operation where there is no common or shared ground.

The BHA-1 provides two different connector options for balanced operation:

- Using a single 4 pin XLR connector (e.g. Neutrik NC4MC-B), the left driver is connected as follows:

LEFT+ → pin 1 RIGHT+ → pin 3
 LEFT- → pin 2 RIGHT- → pin 4

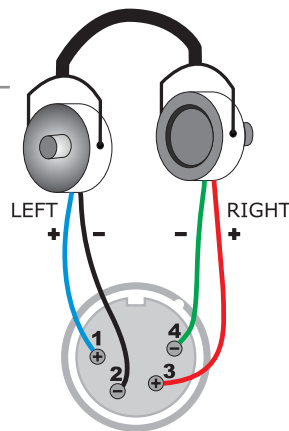

4 PIN MALE XLR PLUG
Neutrik NC4MX-B

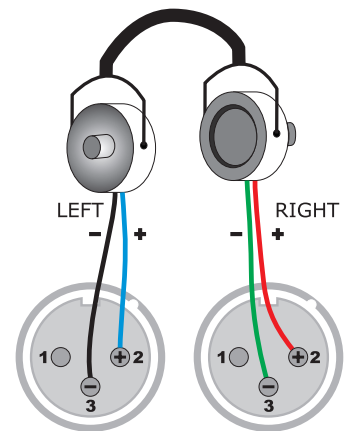

3 PIN MALE XLR PLUGS
Neutrik NC3MX-B

- Using two 3 pin XLR plugs (e.g. Neutrik NC3MX-B) wire the two connectors as follows:

LEFT connector + → pin 2 RIGHT connector + → pin 2
 LEFT connector - → pin 3 RIGHT connector - → pin 3

BHA-1 REAR & FRONT PANEL LEGENDS



FRONT PANEL

1: INPUT SELECT SWITCH

Select between Balanced (XLR 3 pin female), RCA (unbalanced or single-ended) and MINI (3.5mm TRS or 3 conductor mini *Phone* jack)

2: GAIN SELECT SWITCH

Select between **LOW** (14dB decibels, gain = 5) or **HIGH** (20 decibels, gain = 10)

3: VOLUME CONTROL

4: BALANCE CONTROL

With centre detent.

5: BALANCED OUTPUTS

Using two 3 pin XLR jacks, one for the left channel output and another for the right channel output. Pin 1 is ground, pin 2 is the positive phase and pin 3 is the negative phase. See page 5 and 6 for more wiring details.

6: BALANCED OUTPUT (4 PIN XLR)

This 4 pin XLR jack is wired in parallel to the dual 3 pin XLR jacks (see above), therefore do not use both the dual 3 pin XLR's and the single 4 pin XLR output at the same time.

Pin 1 = Left + Pin 3 = Right +
Pin 2 = Left - Pin 4 = Right -

7: SINGLE ENDED OUTPUT

Quarter inch stereo *phone* jack, also referred to as a ¼ inch TRS (Tip-Ring-Sleeve) connec-

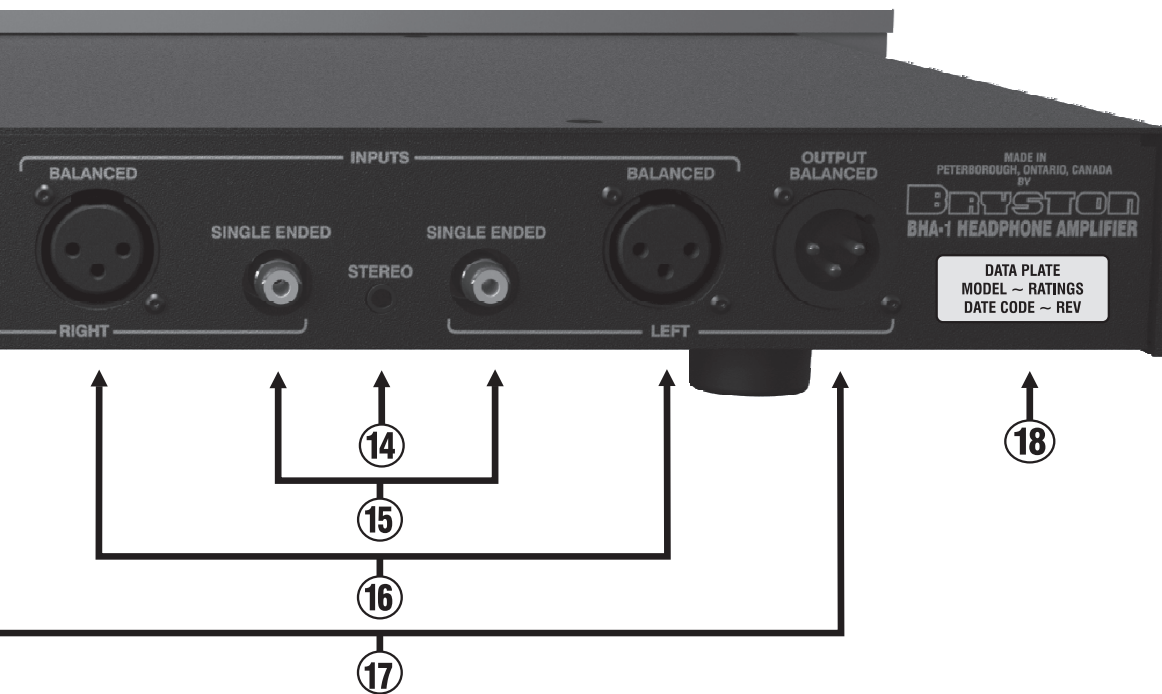
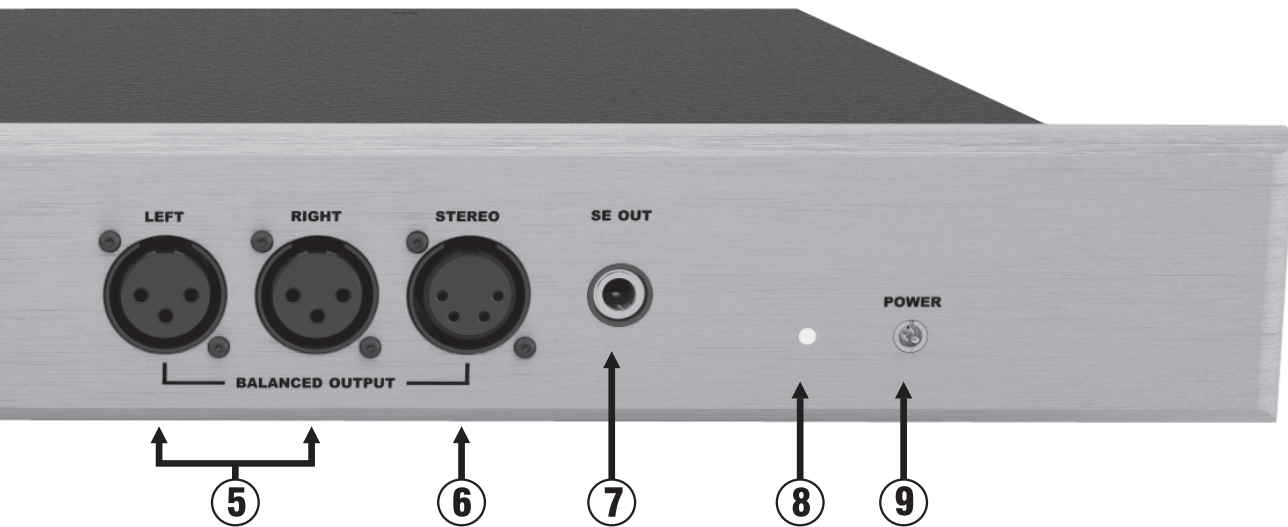

tor, or a 3 conductor ¼ inch phone jack. This single ended or unbalanced output uses only one of two output stages and therefore delivers only half the available power.

- TIP = Left channel
- RING = Right channel,
- SLEEVE = ground (or common)

8: STATUS LED

LED lights green when the BHA-1 is turned ON. When the BHA-1 with the external power supply option is properly connected to an MPS-2 external power supply & the MPS-2 is turned ON but the BHA-1 is turned OFF, the LED will light red to indicate that external power is available.

9: POWER SWITCH

The UP position is ON and the DOWN position is OFF. There is no standby mode in the BHA-1. However, when the power switch is OFF it is still possible to turn the unit on via the Remote Trigger Input on the rear panel (see Rear Panel, item 11 and also **Remote Turn On** on page 5)

REAR PANEL

10: FUSE DRAWER

Turn off unit and disconnect power cord before attempting to replace the fuse. Replace the fuse only with the same type and value as stated on the fuse label on the rear panel next to the fuse drawer/power inlet module.

11: IEC 60320-C14 POWER INLET

Mates with C13 power cord connector.

12: FUSE LABEL & WARNINGS.

Follow all warnings and cautions.

13: REMOTE TRIGGER INPUT

When the power switch (item #9) is turned off (down) the unit can still be powered on by applying 12 volts DC at 50mA, across the two TRIGGER INPUT pins. A two position mating screw terminal connector (Bryston part number CO-110A-11102) is included with each unit. (see next page for hookup details)

14: STEREO MINI-JACK INPUT

A 3.5mm 3 conductor gold plated phone jack for connecting any audio analog audio source like MP3 players, etc. Corresponds to the "MINI" position of the input selector switch (item #1).

15: SINGLE ENDED INPUTS

One pair of RCA jacks, gold plated, for connecting line level analog audio inputs

16: BALANCED INPUTS

3 pin female XLR jacks, gold plated, for connecting balanced analog audio input signals the BHA-1.

- Pin 1 = ground
- Pin 2 = positive phase
- Pin 3 = negative phase

17: BALANCED OUTPUTS

3 pin male XLR jacks, gold plated, for connecting balanced analog audio signals to the inputs of other compatible equipment.

18: DATA PLATE LABEL

Lists the model name, electrical ratings, serial number, manufacturing date code (yyww, where the first two digits represent the two least significant digits of the year, and the last two digits represent the week of the year).

CONNECTING Special Order BHA1-X HEADPHONE AMP to the MPS2 POWER SUPPLY

The BHA-1 is available without an internal power supply on a special order basis. These models require a Bryston MPS-2 external power supply and an interconnecting cable as shown below. The required cable assembly is Bryston part number 101175. Because of the higher power consumption of the BHA-1, compared to the power requirements of preamps the MPS-2 is normally paired with, two of the MPS-2's four outputs must be used to power a single BHA-1.

When the MPS-2 is properly connected to the BHA-1 and the MPS-2 is turned on but the BHA-1 is turned off, the BHA-1's front panel status indicator LED will light red. This indicates that power is available to the BHA-1. Once the BHA-1 is turned on, either by the front panel On/Off switch or remotely by via the Remote Trigger connection, the LED will light green.

MPS2 ~ BHA1 POWER CABLE ASSEMBLY 101175

for powering BHA-1 Headphone Amps from the MPS2 power supply

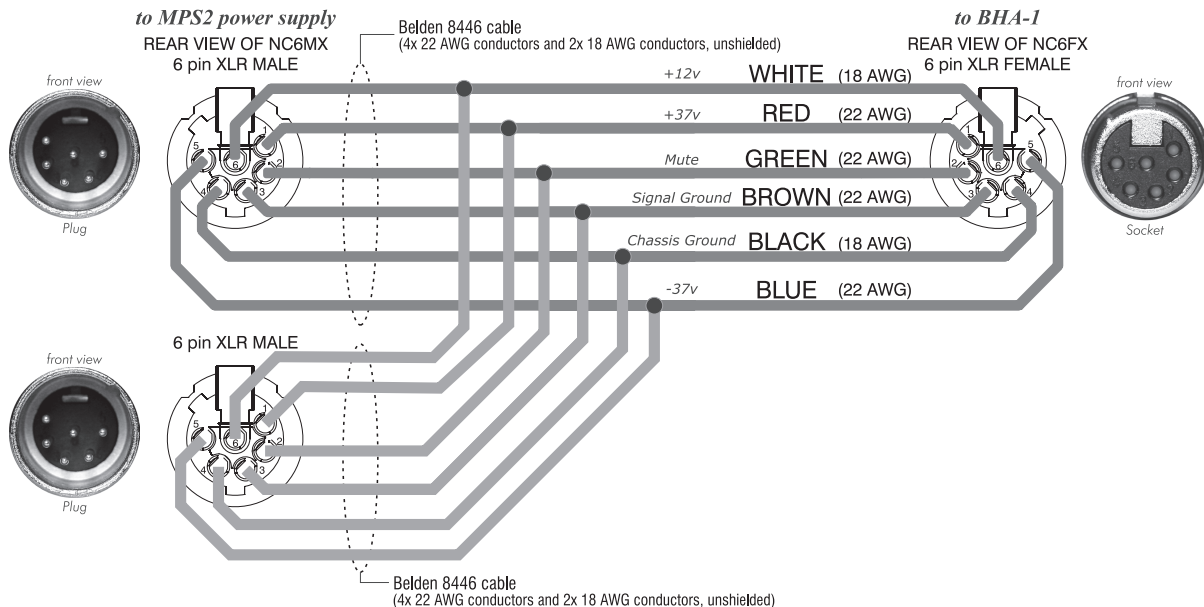

REMOTE TRIGGER HOOKUP

When the front panel power switch (item #9) is turned off (down) the unit can still be powered on by applying 12 volts DC at 50mA, across the two TRIGGER INPUT pins. Because the Remote Trigger Input is rectified and regulated the polarity of the this input voltage doesn't matter. The Trigger voltage can be supplied form any safe external source. A two position mating screw terminal connector (Bryston part number CO-110A-11102) is included with each unit. Do not over tighten the terminal set screws as this can actually cause the connection to loosen over time. Maximum torque is 4.5 inch-pounds (0.5Nm). Stranded copper wire between 24 and 18 AWG is recommended. Strip 1/4" of insulation off the end of the wires to be connected to the CO-110A-11102. The wire ends should be bare copper; not tinned.

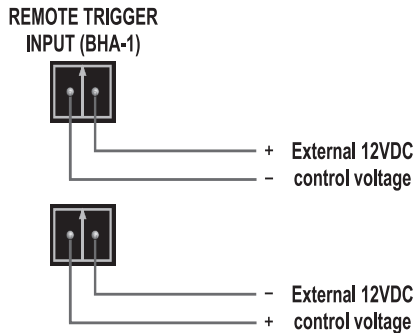

The Remote trigger input is non-polarized so either output wire can go to either input pin.

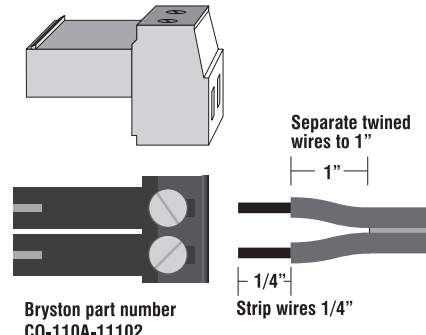

Tighten wires with no more than 0.5Nm torque

BHA-1 SPECIFICATIONS

POWER OUTPUT: (continuous)	Maximum: 2 Watts per channel into 32 Ohms at 1% THD Rated: 500 milliwatts per channel into 32 Ohms at .005% THD.
INPUT IMPEDANCE:	10K ohms single ended (unbalanced) +15K/-5K ohms double ended (balanced)
SENSITIVITY:	HI (approx 20 dB) setting: $70mV_{in} = 100 mW_{out}$ into 50 ohms ($500mV_{in} = 5V_{out}$) LO (approx 14 dB) setting: $140mV_{in} = 100 mW_{out}$ into 50 ohms ($500mV_{in} = 2.5V_{out}$)
DISTORTION:	THD+noise: < 0.005% 20 Hz to 20 kHz IMD: < 0.001% 60 Hz + 7 kHz mixed 4:1
NOISE:	Measured with input shorted (20 Hz to 20 kHz.) >103 dBv (with 20 Hz to 22 kHz band pass filter)
FREQUENCY RESPONSE:	20 Hz to 20 kHz @ ± 0.1 dB.
POWER BANDWIDTH:	<1 Hz to over 100 kHz
POWER CONSUMPTION:	50 Watts
HEAT LOAD:	130 BTU/hr
DIMENSIONS:	Maximum overall dimensions with C-series front panel & feet: 17" dress panel: 2.713" high & 11.1" deep (432mm • 69mm • 282mm) 19" dress panel: 2.713" high & 11.1" deep (483mm • 69mm • 282mm) Maximum overall dimensions with Rack mount panel & feet: 19" wide, 2.45" high & 11.1" deep (483mm • 62.2mm • 282mm) Maximum overall dimensions with Rack mount panel but without feet: 19" wide, 2.45" high & 11.1" deep (483mm • 62.2mm • 282mm) (See page 8 for more details)
WEIGHT:	unit alone: 11.7 lbs (5.3 kg) approx. with packaging 16.5 lbs (7.5kg) approx.

BHA-1 OVERALL SCHEMATIC

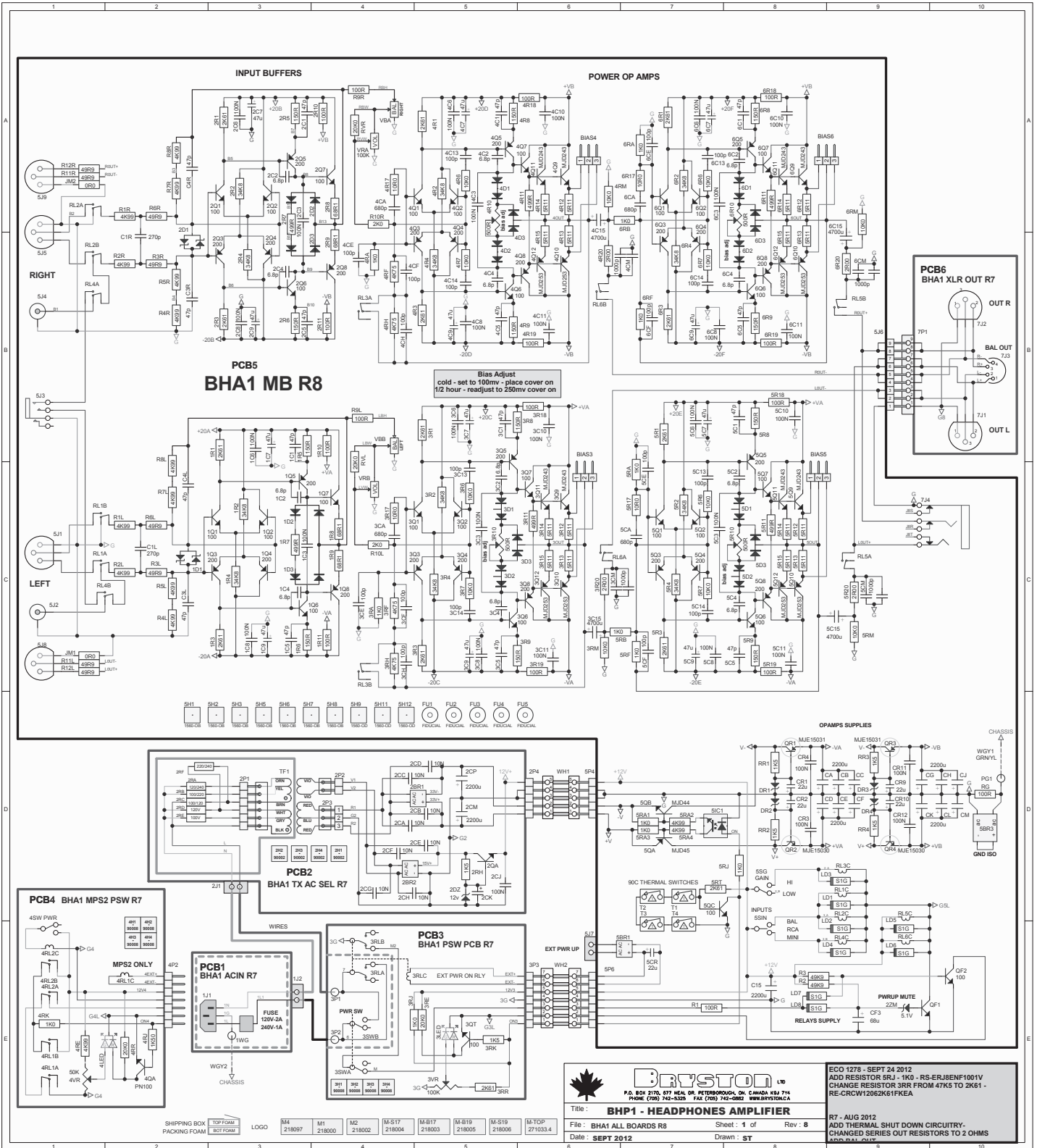

BHA-1 EXTERNAL DIMENSIONS

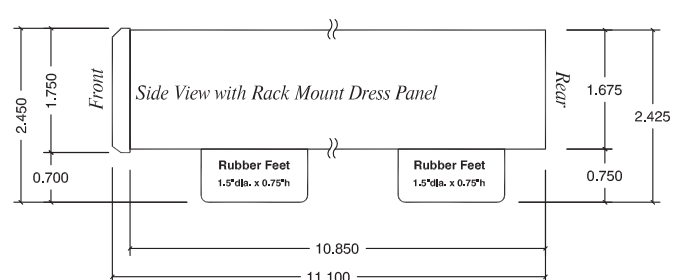
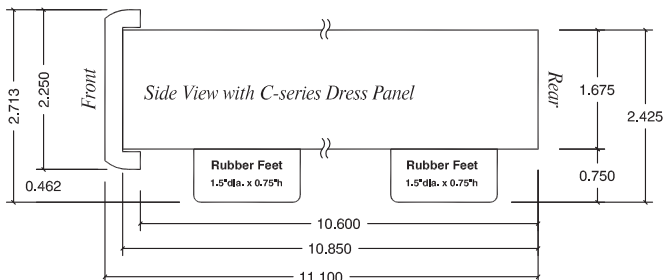
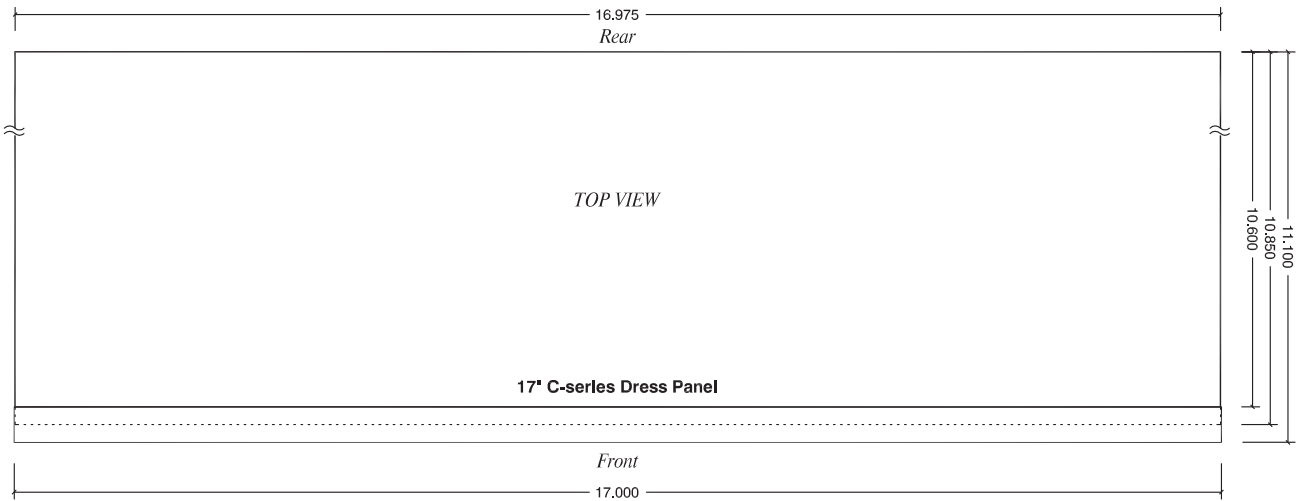
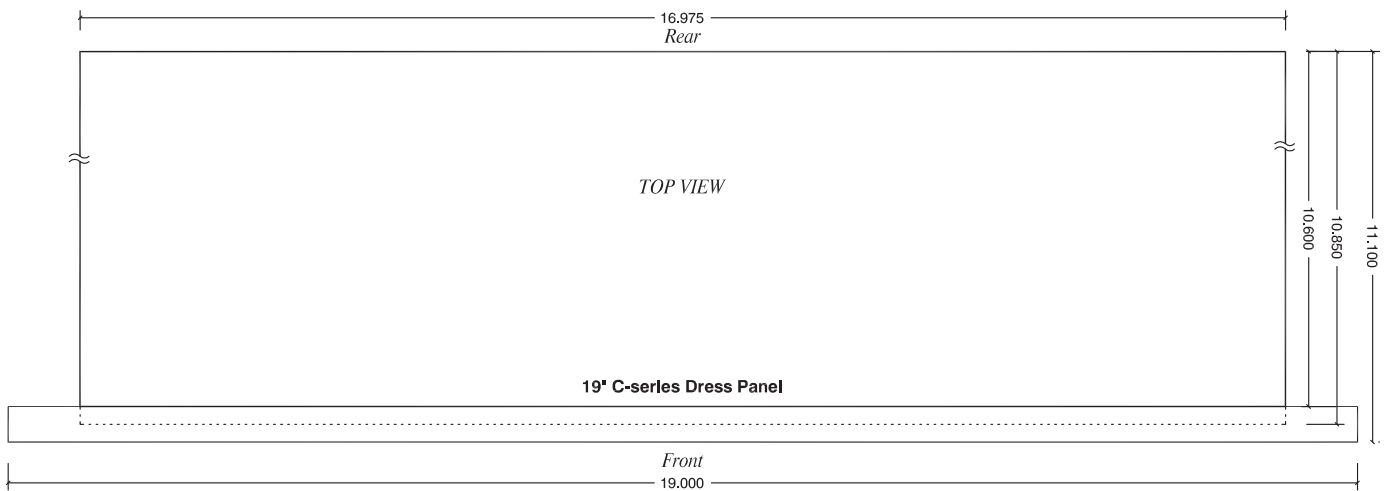
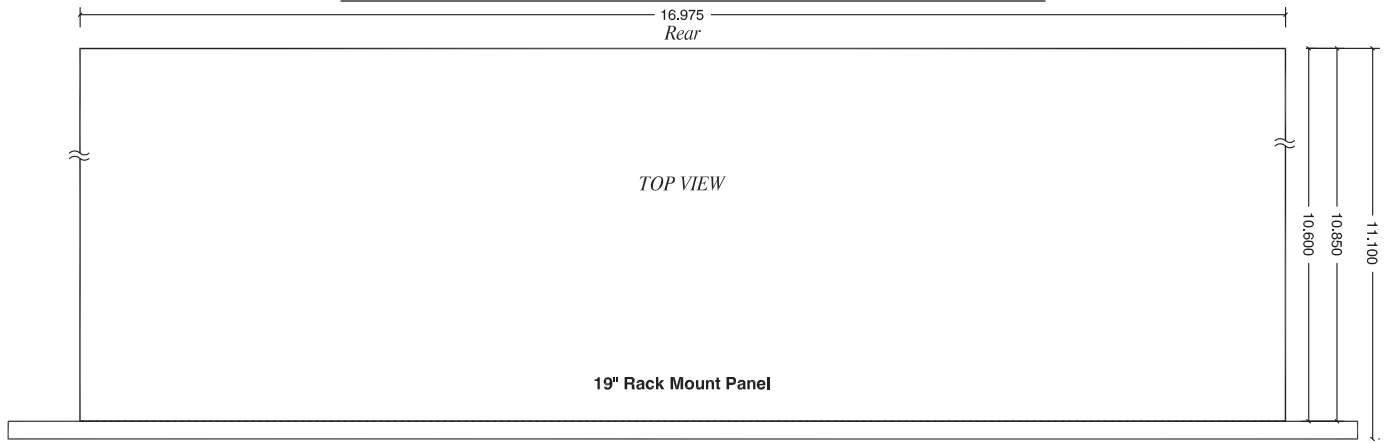



 **There are no user serviceable parts inside the BHA-1. Please refer any servicing to qualified personnel.**

300028-6-bha1-20130219

BRYSTON LTD., PETERBOROUGH, ONTARIO, CANADA

